

B-83-30-R

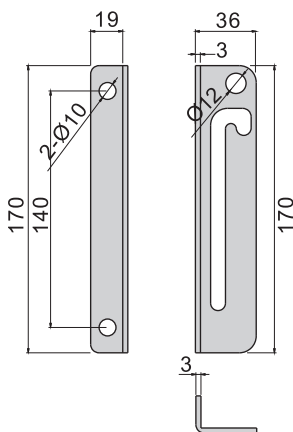

材 质	B-1083-30---不锈钢(SUS 304)
	B-83-30、B-833-36---铁
表面处理	B-83-30、B-833-36---电著涂装黑色
	B-83-S1~S4---电著涂装黑色
	B-83-Φ19、B-83-Φ22---镀铬
备 注	B-1083-30、B-83-30分左开, 右开。

B-1083-30-R
B-83-30-R



B-1083-30-L
B-83-30-L

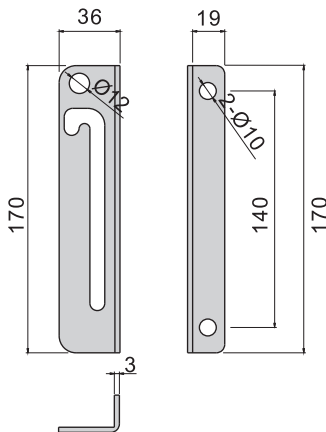

B-833-36

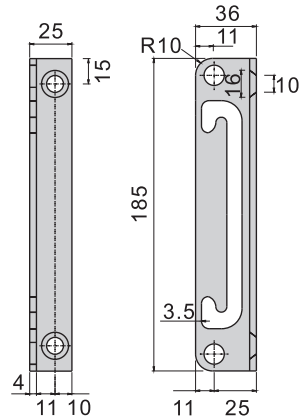

B-83-Ø19

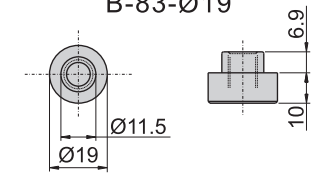

B-1083-Ø22
B-83-Ø22

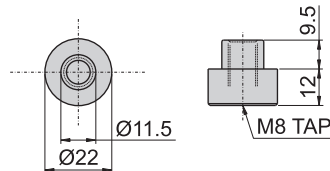

B-1083-M8
B-83-M8



五金件

B-1083-S1
B-83-S1

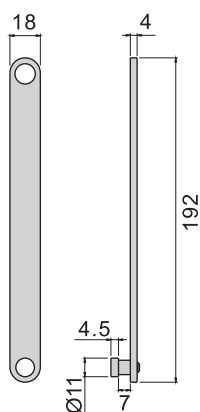

B-1083-S2
B-83-S2

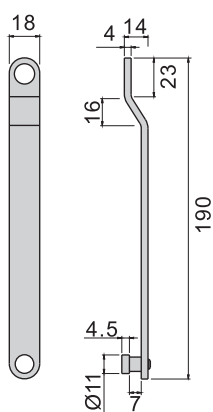

B-1083-S3
B-83-S3

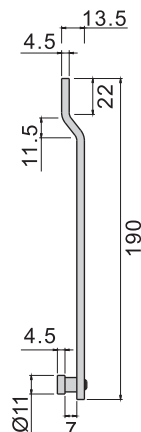

B-1083-S4
B-83-S4

